

ICOM

INSTRUCTION MANUAL

HF MARINE TRANSCEIVER  
**IC-M710**



Icom Inc.

---

## IMPORTANT

---

**READ THIS INSTRUCTION MANUAL CAREFULLY** before attempting to operate the transceiver.

**SAVE THIS INSTRUCTION MANUAL**—This instruction manual contains important safety and operating instructions from the IC-M710.

**NOTE:** To meet the European GMDSS regulations (ETS300 338, ETS300 373), the following must be connected to the IC-M710GMDSS version:

- GM-110 DSC TERMINAL UNIT
- PS-65 (OR 66) DC-DC CONVERTER UNIT
- AT-130E AUTOMATIC ANTENNA TUNER

---

## PRECAUTIONS

---

**⚠ WARNING! NEVER** connect the transceiver to an AC outlet directly. This may pose a fire hazard or result in an electric shock.

**⚠ WARNING! NEVER** mount the transceiver overhead. The weight of the transceiver is approximately 8 kg, but its apparent weight will increase several fold due to wave shocks or vibration. The transceiver must be mounted on a flat hard surface only.

**NEVER** connect a power source of more than 16 V DC such as a 24 V battery. This connection will ruin the transceiver.

**NEVER** place the transceiver where normal operation of the ship or vehicle may be hindered or where it could cause bodily injury.

**NEVER** allow children to touch the transceiver.

**NEVER** expose the transceiver to rain, snow or any liquids.

There are two types of grounding systems available for the IC-M710 — Negative Ground and Floating Ground — **NEVER** install the negative ground type to a plus-grounding ship. Such a connection might blow fuses and is not usable.

---

## EXPLICIT DEFINITIONS

---

The explicit definitions described below apply to this instruction manual.

WORD	DEFINITION
<b>⚠ WARNING</b>	Personal injury, fire hazard or electric shock may occur.
<b>CAUTION</b>	Equipment damage may occur.
<b>NOTE</b>	If disregarded, inconvenience only. No risk of personal injury, fire or electric shock.

**NOTE:** The IC-M710 GMDSS version has a high-stability crystal oscillator unit. This unit draws a slight current even when power to the transceiver is OFF. To prevent battery exhaustion when docking your vessel for extended periods, unplug the DC cable from the DC power receptacle.

**DO NOT** use chemical agents such as benzene or alcohol when cleaning, as they can damage the transceiver surfaces.

In maritime mobile operation, **KEEP** the transceiver and microphone **as far away** as possible (at least 1 m) from the magnetic navigation **compass** to prevent erroneous indications.

**USE** an Icom microphone and/or handset only (supplied or optional). Other brands may have different pin assignments and may damage the transceiver.

**AVOID** using or placing the transceiver in areas with temperatures below  $-20\text{ }^{\circ}\text{C}$  ( $-4\text{ }^{\circ}\text{F}$ ) or above  $+60\text{ }^{\circ}\text{C}$  ( $+140\text{ }^{\circ}\text{F}$ ).

**AVOID** connecting the transceiver to a power source using reverse polarity. This connection will not only blow fuses but may also damage the transceiver.

**AVOID** placing the transceiver in excessively dusty environments or in direct sunlight.

**AVOID** placing the transceiver against walls or putting anything on top of the transceiver. This will obstruct heat dissipation.

## IN CASE OF EMERGENCY (for maritime operation)

If your vessel requires assistance, contact other vessels and the Coast Guard by sending a distress call on 2182 kHz.

Or, transmit your distress call using digital selective calling on 2187.5 kHz

### ◇ USING 2182 kHz WITH VOICE

- ① Push [2182kHz] to select the emergency frequency.
- ② Push [ALARM] and [TX FREQ] for 1 sec. to transmit a two-tone alarm signal for at least 30 sec.
  - The transceiver automatically stops the alarm after 50 sec.
- ③ Push [ALARM] to turn OFF the alarm transmission, then push and hold the PTT switch on the microphone and send the following information.
  1. "MAYDAY, MAYDAY, MAYDAY."
  2. "THIS IS ....." (name of vessel)
  3. "LOCATED AT ....." (Vessel's position)
  4. Give the reason for the distress call.
  5. Explain what assistance you need.
  6. Give additional information:
    - Vessel type
    - Vessel length
    - Vessel color
    - Number of people onboard.

### ◇ USING DIGITAL SELECTIVE CALLING (Only for GMDSS versions with an optional GM-110DSC DSC TERMINAL UNIT)

#### *When immediate help is needed*

- ① Push and hold [EMERGENCY] on the GM-110DSC for 5 sec., until the short beeps become one long beep, to send the distress call.
- ② After 2182 kHz is automatically selected, transmit the appropriate information as at left using voice.

#### *When a potential problem exists*

- ① Push [SEL] on the GM-110DSC, then select "All ships call" with [ENT] and DATA SELECTOR.
- ② Push and hold [CALL] on the GM-110DSC for 5 sec., until short beeps become one long beep, to use the "all ships call" function.
- ③ After the pre-selected frequency is selected, transmit the appropriate information using voice.
  - DSC equipped ships may monitor your transmission.

## VERSIONS

The following versions are available for the IC-M710.

Version	Ground type	Descriptions
<b>GMDSS</b>	Negative ground and Floating ground	Corrosion-resistant exterior. High stability crystal and FSK narrow filter built-in. Optional DSC terminal unit can be connected. 2182 kHz 2-tone alarm is built-in.
<b>Marine</b>	Negative ground and Floating ground	2182 kHz 2-tone alarm is built-in. FSK/CW narrow filter is optional. All SSB/FSK ITU channels available.
<b>General</b>	Negative ground only	2182 kHz 2-tone alarm is optional. No transmit frequency programming allowed. ITU channels are optional.

---

# TABLE OF CONTENTS

---

IMPORTANT .....	i	<b>5 USER CHANNEL PROGRAMMING .....</b>	<b>11</b>
EXPLICIT DEFINITIONS .....	i	■ Programming a frequency .....	11
PRECAUTIONS .....	i	◇ Receive frequency .....	11
		◇ Transmit frequency .....	11
		◇ Channel name .....	11
IN CASE OF EMERGENCY .....	ii	<b>6 SET MODE .....</b>	<b>12 – 14</b>
VERSIONS .....	ii	■ Set mode operation .....	12
		■ Set mode contents .....	12
TABLE OF CONTENTS .....	iii	<b>7 CONNECTIONS AND INSTALLATION .....</b>	<b>15 – 21</b>
<b>1 OPERATING RULES AND GUIDELINES .....</b>	<b>1</b>	■ Connections on rear panel .....	15
<b>2 PANEL DESCRIPTION .....</b>	<b>2 – 4</b>	■ Unpacking .....	15
■ Front panel .....	2	■ Connector information .....	16
■ Display .....	4	■ Ground connection .....	18
<b>3 SELECTING A CHANNEL .....</b>	<b>5 – 7</b>	■ Power source .....	18
■ Selecting a channel .....	5	■ Antenna .....	19
◇ Using the channel selector .....	5	◇ MN-100/MN-100L .....	19
◇ Using the keypad .....	6	◇ AT-130/AT-130E .....	19
◇ Using scan functions .....	6	◇ Non-Icom tuner .....	19
■ Selecting a frequency .....	7	■ Mounting .....	20
◇ Using the channel selector .....	7	◇ Mounting location .....	20
◇ Using the keypad .....	7	◇ Mounting example .....	20
		◇ Transceiver dimensions .....	20
<b>4 RECEIVE AND TRANSMIT .....</b>	<b>8 – 10</b>	■ Installing options .....	21
■ Basic voice receive and transmit .....	8	◇ Opening the case .....	21
■ Functions for transmit .....	8	◇ Installing an optional filter and alarm unit .....	21
◇ Transmit frequency check .....	8	■ Fuse replacement .....	21
◇ Transmit power selection .....	8	<b>8 TROUBLESHOOTING .....</b>	<b>22</b>
■ Functions for receive .....	9	<b>9 SPECIFICATIONS AND OPTIONS .....</b>	<b>23</b>
◇ Squelch function .....	9	■ Specifications .....	23
◇ Noise blanker .....	9	◇ General .....	23
◇ AGC off function .....	9	◇ Transmitter .....	23
◇ RF gain setting .....	9	◇ Receiver .....	23
◇ Clarity control .....	9	■ Options .....	23
■ CW operation .....	10		
■ FSK operation .....	10		
■ Cross channel operation .....	10		

Before transmitting, monitor the channel you wish to use so as to avoid interrupting transmissions already in progress.

## • CALL PROCEDURES

Calls must be properly identified and time limit must be respected.

- ① Give your call sign each time you call another vessel or coast station. If you have no call sign, identify the station by giving your vessel name and the name of the licensee.
- ② Give your call sign at the end of each transmission that lasts more than 3 min.
- ③ You must break and give your call sign at least once every 15 min. during long ship-to-shore calls.
- ④ Keep your unanswered calls short, less than 30 sec. Do not repeat a call for 2 min.
- ⑤ Unnecessary transmissions are not allowed.

## • PRIORITIES

- ① Read all rules and regulations pertaining to priorities and keep an up-to-date copy handy. Safety and distress calls take priority over all others.
- ② False or fraudulent distress signals are prohibited and punishable by law.

## • PRIVACY

- ① Information overheard but not intended for you cannot lawfully be used in any way.
- ② Indecent or profane language is prohibited.

## • LOGS

- ① All distress, emergency and safety calls must be recorded in complete detail. Log data activity is usually recorded in 24 hour time. Universal Time (UTC) is frequently used.
- ② Adjustments, repairs, channel frequency changes and authorized modifications affecting electrical operation of the equipment must be kept in the maintenance log; entries must be signed by the authorized licensed technician performing or supervising the work.

## • RADIO LICENSES

### (1) SHIP STATION LICENSE

You must have a current radio station license before using the transceiver. It is unlawful to operate a ship station which is not licensed.

Inquire through your dealer or the appropriate government agency for a Ship-Radiotelephone license application. This government-issued license states the call sign which is your craft's identification for radio purposes.

### (2) OPERATOR'S LICENSE

A Restricted Radiotelephone Operator Permit is the license most often held by small vessel radio operators when a radio is not required for safety purposes.

The Restricted Radiotelephone Operator Permit must be posted or kept with the operator. Only a licensed radio operator may operate a transceiver.

However, non-licensed individuals may talk over a transceiver if a licensed operator starts, supervises, and ends the call, and makes the necessary log entries.

Keep a copy of the current government rules and regulations handy.

# 2 PANEL DESCRIPTION

## Front panel

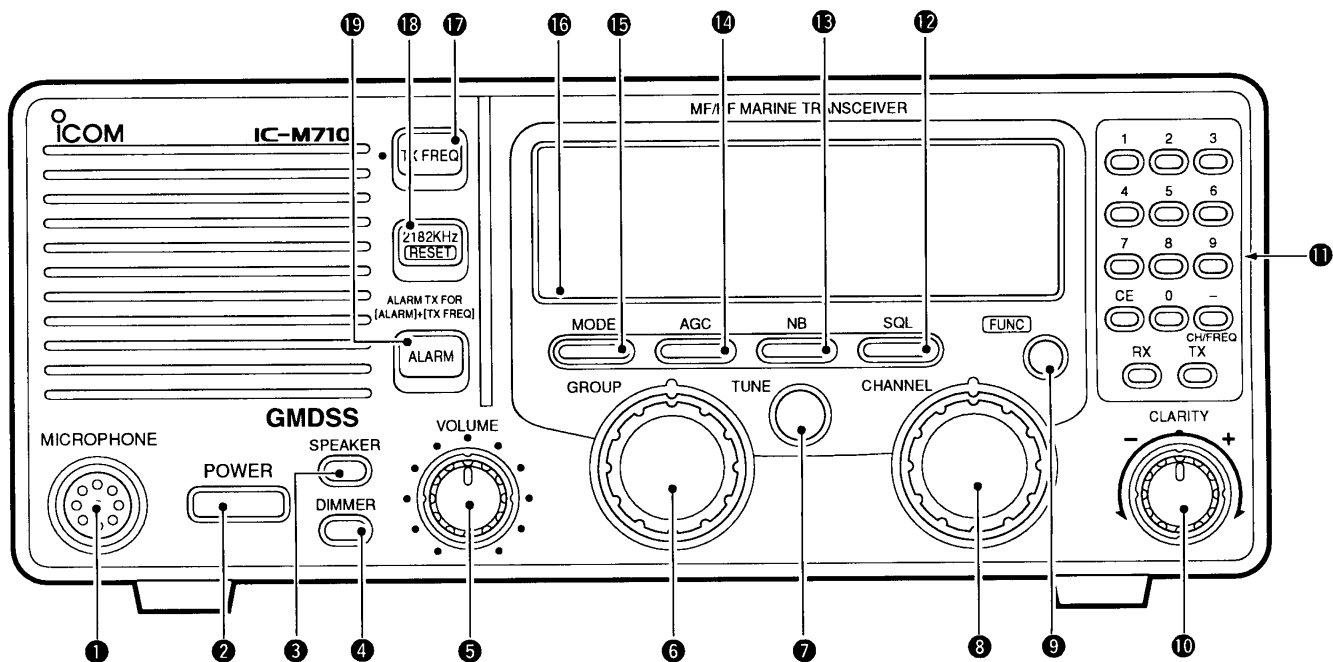

### 1 MICROPHONE CONNECTOR (p. 16)

Accepts the supplied microphone or an optional handset.

**NOTE:** No audio is output via the speaker when microphone or headset is not connected.

### 2 POWER SWITCH

Turns power ON and OFF.

### 3 SPEAKER OFF SWITCH

Turns the speaker ON and OFF.

- "🔊" appears on the display while the speaker is turned OFF.

- Any external speaker connected to the rear panel is not turned OFF.

### 4 DISPLAY INTENSITY SWITCH [DIMMER]

• Dims the display backlight.

• Push [FUNC], then select intensity level via the channel selector dial while pushing [DIMMER]. (GMDSS version only)

### 5 VOLUME CONTROL

Adjusts the audio output level.

- Audio does not come from the speaker when:

- A microphone is not connected.
- The [SPEAKER] switch is turned ON.
- The [SQL] switch is turned ON and no signal is being received.

### 6 GROUP CHANNEL SELECTOR

Selects groups in 20 channels steps and ITU marine channel groups.

**NOTE:** Some versions have no ITU channels.

### 7 ANTENNA TUNE SWITCH (p. 8)

Tunes the connected tuner to the antenna.

- Activates only when an optional antenna tuner such as Icom's AT-130/E is connected.

**NOTE:** When selecting "Automatic tuning" in set mode, this [TUNE] switch is not necessary.

Confirm your set condition. (p. 12)

### 8 CHANNEL SELECTOR (p. 5)

• Selects an operating channel within the selected channel group such as ITU channels.

- User channels can be selected from 1 to 160 (max.) in sequence regardless of the channel group.

• Changes the operating frequency\* after [CE] is pushed (while "▶" appears).

- The changed frequency is not programmed in this way.

### 9 FUNCTION SWITCH [FUNC]

After pushing, activates the secondary functions of these switches:

- [RESET] . . . . . Deactivates external control such as from a DSC terminal unit when connected.

- [SQL] . . . . . Starts and stops scan (p. 6).

- [RX] . . . . . Sets RF gain (p. 9).

- [TX] . . . . . Selects transmit power (p. 8).

- [CE] . . . . . Reprograms the channel name (p. 11)

**NOTE:** Function availability depends on versions.

### 10 CLARITY CONTROL (p. 9)

Shifts the receive frequency  $\pm 150$  Hz for clear reception of an off frequency signal.

**11 KEYPAD**

- Enters the selected channel number (or frequency\*) for direct channel selection. (p. 6)
- Stores a receive frequency into a user channel or ITU simplex channel when:
  - pushing [CE] (“▶” appears)
  - entering the desired frequency via the keypad
  - pushing and holding [RX] (p. 9)
- Adjusts the RF gain after pushing [FUNC] to reduce the receiver sensitivity. (p. 9)



- Stores a transmit frequency into a user channel (except General versions) when:
  - pushing [TX] (“TX” blinks)
  - pushing [CE] (“▶” appears)
  - entering the desired frequency via the keypad
  - pushing and holding [TX] (p. 11)
- Selects the transmitter channel for cross channel operation (Europe versions only) when:
  - pushing [TX] (“TX” blinks)
  - entering the desired channel number via the keypad
  - pushing [TX] (p. 10)
- Selects the transmit output power after pushing [FUNC]. (p. 8)



- Toggles the channel number input and frequency input\*. (p. 7)
  - “▶” appears when frequency input\* is selected.
  - The channel selector and keypad changes the frequency while “▶” appears.
- Clears the entered digit and retrieves the previous channel (or frequency\*) while entering numbers. (p. 6)
- Enters the name programming condition, after pushing [FUNC], for changing the channel name. (p. 11)



- Toggles the channel and frequency indications. (p. 5)
- Enters “-” for ITU simplex channels. (p. 6)

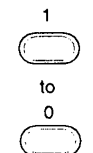

- Enter channel number with up to 4 or 5 digits when “▶” does not appear. (p. 6)
- Enter the frequency with up to 6 digits\* when “▶” appears. (p. 7)

**12 SQUELCH SWITCH [SQL] (p. 9)**

- Activates the voice squelch function to reject undesired background noise while no signal is being received.

- The squelch opens only when the received signal contains voice or FSK components.
- Starts and stops the scan function after pushing [FUNC]. (p. 6)

**13 NOISE BLANKER SWITCH [NB] (p. 9)**

- Turns the noise blanker function ON to remove pulse-type noise such as engine ignition noise.
  - “NB” appears when the function is turned ON.

**14 AGC OFF SWITCH [AGC] (p. 9)**

- Deactivates the AGC function to receive weak signals blocked by strong adjacent signals.
  - “AGC” appears when the [AGC] switch is turned ON (stands for AGC deactivated)

**15 MODE SWITCH (p. 8)**

- Selects an operating mode temporarily. Available modes differ according to version.
  - J3E(USB), H3E, J2B(AFSK), FSK, R3E and A1A(CW) modes are available.
  - The temporary mode is cleared and the previous mode appears when changing a channel.

**16 OVEN INDICATOR (GMDSS version only)**

- Internal high-stability crystal oscillator unit contains a temperature-compensating oven heater. This high-stability crystal oscillator improves frequency stability.

**17 TRANSMIT FREQUENCY SWITCH [TX FREQ] (p. 8)**

- Displays the transmit frequency and opens the squelch to check and monitor the transmit frequency.

**18 2182kHz SELECTION SWITCH**

- [2182KHz • [RESET] ] (pgs. ii, 5)
  - Selects channel 0 (2182kHz; distress call frequency).
  - The channel selector does not function when selecting channel 0.
  - Ignores external control and gives the front panel control priority when an external controller (NMEA format) is connected (except DSC terminal unit).

**19 ALARM SWITCH (p. ii)**

- Emits a distress alarm signal from the speaker.
- Transmits a distress alarm or alarm testing signal when pushed together with the [TX FREQ] switch.
- ▨ **NOTE:** General versions are not equipped with this [ALARM] switch.

\* Some versions do not have frequency selection and frequency indication.

## Display

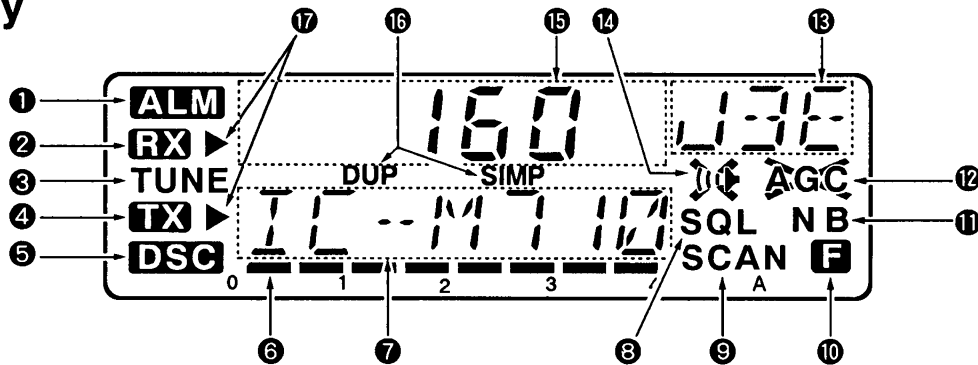

- 1 ALARM INDICATOR** (p. ii)  
 Appears when the alarm function is activated such for an alarm test or distress alarm transmission.  
 - Not available on General version.
- 2 RECEIVE INDICATOR** (p. 9)  
 Appears while receiving and when the squelch is open.
- 3 TUNE INDICATOR** (p. 8)  
 Blinks while the connected antenna tuner, such as Icom's AT-130/E, is being tuned.  
 - Tuning starts when transmitting on a new frequency or pushing the [TUNE] switch.
- 4 TRANSMIT INDICATOR**  
 • Appears while transmitting. (p. 8)  
 • Blinks when the [TX] key is pushed for transmit frequency programming. (p. 11)
- 5 DSC INDICATOR** (p. ii)  
 Appears when an optional GM-110DSC DSC TERMINAL UNIT controls transceiver functions.  
 - The GM-110DSC can be connected to GMDSS versions only.
- 6 S/R F METER**  
 • Shows the relative received signal strength while receiving.  
 • Shows output power while transmitting.  
 • Shows antenna current level when an optional AT-130E HF ANTENNA TUNER is connected (Europe versions only).
- 7 CHANNEL NAME READOUT**  
 • Shows the pre-programmed channel name (alphanumeric) during channel indication. (p. 5)  
 - Some versions have no channel name function and show receive frequency instead.  
 • Shows the transmit frequency during frequency indication. (p. 5)  
 • Shows transmit channel number during cross channel operation (Europe versions only). (p. 10)
- 8 SQUELCH INDICATOR** (p. 9)  
 Appears when the squelch is ON.
- 9 SCAN INDICATOR** (p. 6)  
 Appears when the scan function is in use.  
 - The scan function is not available on some versions.  
 - Pushing [FUNC] then [SQL] starts and stops scan.
- 10 FUNCTION INDICATOR**  
 Appears when the [FUNC] switch is pushed.  
 - Some switches activate secondary functions.
- 11 NOISE BLANKER INDICATOR** (p. 9)  
 Appears when the [NB] switch is turned ON.
- 12 AGC OFF INDICATOR** (p. 9)  
 Appears when the [AGC] switch is pushed to indicate the AGC function is deactivated.
- 13 MODE READOUT** (p. 8)  
 Shows the selected operating mode (type of emission).
- 14 SPEAKER OFF INDICATOR**  
 Appears when the [SPEAKER] switch is pushed to indicate the front panel speaker is deactivated.
- 15 CHANNEL READOUT**  
 • Shows the selected channel number during channel indication. (p. 5)  
 • Shows the receive frequency during frequency indication. (p. 5)
- 16 SIMPLEX/DUPLEX INDICATORS**  
 These appear to show whether the selected channel is simplex or duplex.
- 17 FREQUENCY INDICATORS** (p. 7)  
 Appear when the frequency entry condition\* is selected for frequency selection.  
 - The [CE] key toggles the indicator ON and OFF.

\* Some versions have no frequency entry condition.



## ■ Selecting a channel

The transceiver has 160 user channels and ITU channels. However, the number of user channels can be optionally restricted and ITU channels are not available with some versions.

**NOTE:** When Channel 0 and/or 2182 kHz is selected with the [2182KHz] switch, channel selection is NOT possible. In such a case, push [2182KHz] in advance.

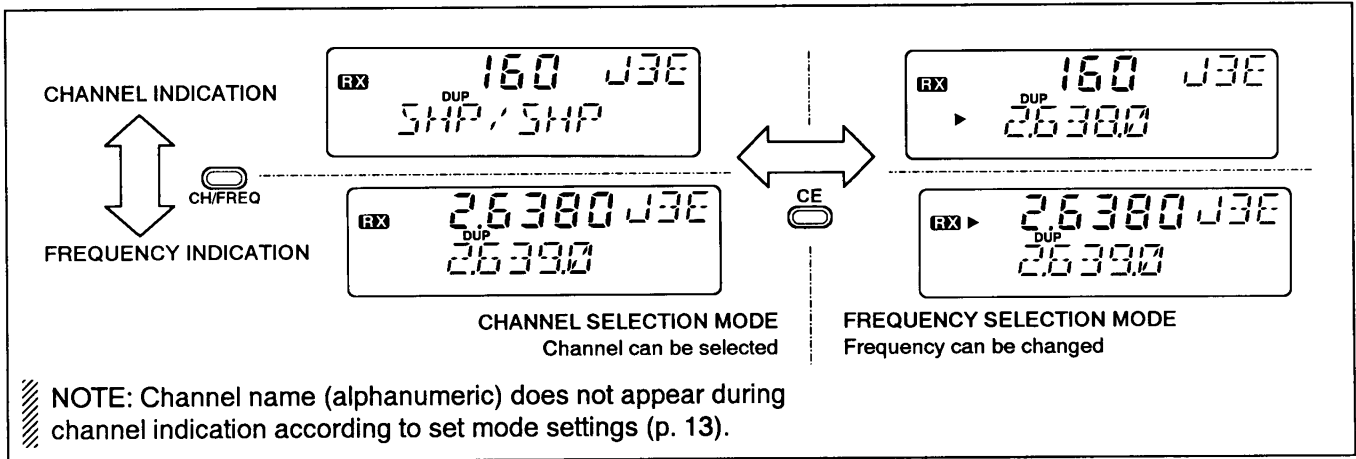

### ◇ Using the channel selector

The transceiver has two large controls for group selection and channel selection. The [GROUP] selector changes channels in 20 channel increments and selects ITU channel groups\*; and the [CHANNEL] selector selects each channel.

- Be sure no "▶" indicator appears on the display.

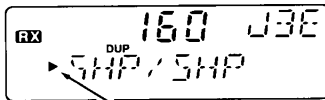

If appears, push [CE] to delete it.

- Rotate the [GROUP] selector to select the desired channel group as shown at right and/or below.
- Rotate the [CHANNEL] selector to select the desired channel.

**[EXAMPLE]:** Selection of the [GROUP] selector

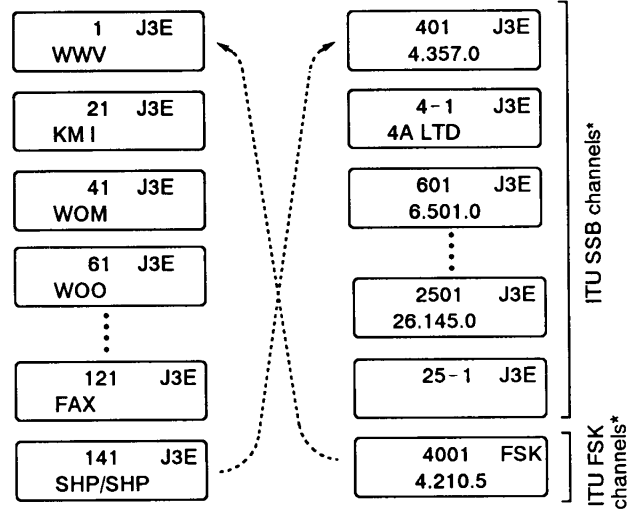

\*All ITU channels are not available with some versions and ITU FSK channels can be hidden using set mode. (p. 12)

### CHANNEL GROUP

CHANNEL NO.	DESCRIPTION	CHANNEL NO.	DESCRIPTION	CHANNEL NO.	DESCRIPTION
1 to 160	User channels ([GROUP] selector changes in 20 channel steps)	8-1 to 8-9	8 MHz ITU simplex channels	2201 to 2253	22 MHz ITU duplex channels
		1201 to 1241	12 MHz ITU duplex channels	22-1 to 22-9	22 MHz ITU simplex channels
401 to 427	4 MHz ITU duplex channels	12-1 to 12-9	12 MHz ITU simplex channels	2501 to 2553	25 MHz ITU duplex channels
4-1 to 4-9	4 MHz ITU simplex channels	1601 to 1656	16 MHz ITU duplex channels	25-1 to 25-9	25 MHz ITU simplex channels
601 to 608	6 MHz ITU duplex channels	16-1 to 16-9	16 MHz ITU simplex channels	4001 to 25040	ITU FSK duplex channels (SITOR use) (No group separation)
6-1 to 6-9	6 MHz ITU simplex channels	1801 to 1815	18 MHz ITU duplex channels		
801 to 832	8 MHz ITU duplex channels	18-1 to 18-9	18 MHz ITU simplex channels		

### 3 SELECTING A CHANNEL

#### ◇ Using the keypad

Direct channel selection via the keypad is available for quick channel selection.

- ① Be sure "▶" does not appear on the display.
  - If it appears, push [CE] to delete it.
- ② Enter the desired channel number via the keypad.
  - A user channel is selected when channel 1–160 is input (max. number may be optionally restricted).
  - An ITU SSB channel is selected when channel numbers higher than 401 are input (not available for some versions).
  - An ITU FSK channel is selected when channel numbers higher than 4001 are input (not usable according to set mode setting).
  - The "-" key can be used for selecting an ITU simplex channel.
- ③ Push [RX] to select the entered channel.

**[EXAMPLE]:** Selecting channel 153.

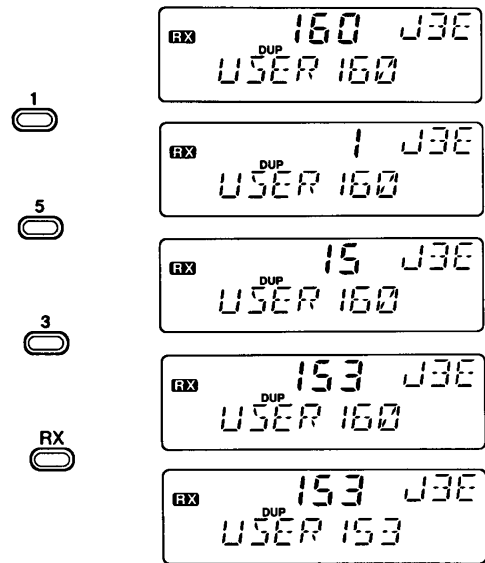

#### ◇ Using scan functions

(Some versions do not have these functions)

The transceiver has automatic channel or frequency change capability (scan function). There are 3 types of scan functions available to suit your needs.

##### Channel scan

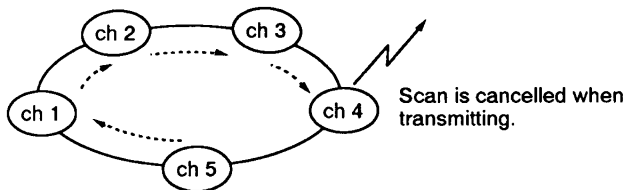

##### Channel resume scan

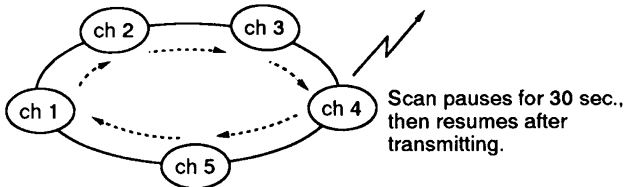

##### Programmed scan (optional)

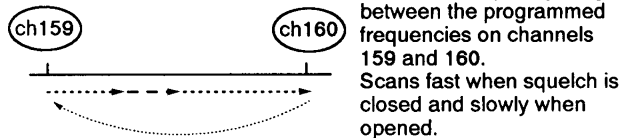

Channel scan and channel resume scan increases channels within a 5 channel range such as ch 1 to ch 5, ch 156 to ch 160, etc. in user channels; or all channels in the group of ITU channels

Programmed scan (optional) changes frequencies within the frequency range between user channels 159 and 160.

Scan selection is available in set mode. See p. 13 for scan selection.

#### SCAN OPERATION

- ① Select your desired channel group with the [GROUP] and [CHANNEL] selector.
  - Or use the keypad and [CE] key for direct selection.
  - This operation is not necessary for programmed scan.
- ② Push [SQL] to turn OFF the squelch function if the programmed scan is selected.
- ③ Push [FUNC] then [SQL] to start the scan.
- ④ To stop the scan, repeat step ③ again.
  - [CHANNEL] rotation and some other switches also stop the scan.

## Selecting a frequency

The transceiver has 0.5 to 30.0 MHz general coverage receive capability with 100 Hz resolution. The receive frequency can be changed instantly, independent of the transmit frequency.

**NOTE:** The selected frequency is used for temporary receiving (transmitting is not available). This frequency is cleared once the channel is changed. If you want to program a frequency, refer to p. 11, memory programming.

### Using the channel selector

- ① Select a channel which is programmed near the frequency you want receive.
- ② Push the [CE] key to select frequency selection mode.
  - "▶" appears on the display.
- ③ Rotate the [CHANNEL] selector to change the frequency.
- ④ To return to the previous frequency, push [CE].
  - "▶" disappears and the previous frequency or channel name appears.

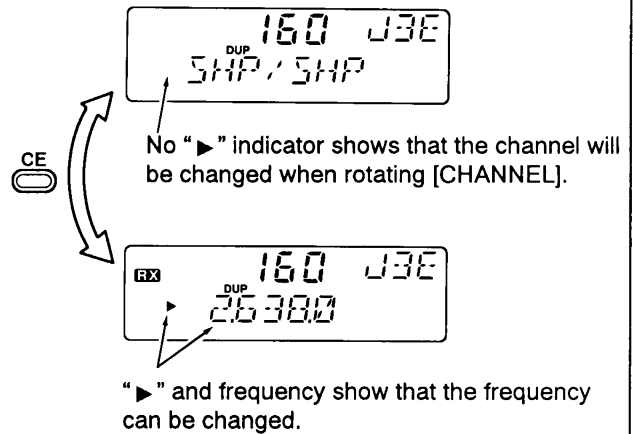

### Using the keypad

**CAUTION:** A frequency can be entered into a user channel or ITU simplex channel by pushing the [RX] key. However, when pushing and holding the [RX] key after entering a frequency, the previously programmed contents are erased and cannot be retrieved. Therefore, keypad entry should be used only on spare channels.

- ① Select the memory channel to be used for general coverage use.

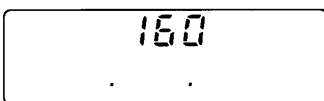

No frequency programmed channel for general coverage use.  
(mode and channel name do not appear)

- ② Push [CE] to select frequency selection mode.
- ③ Enter the desired frequency with 5 or 6 digits.
- ④ Push [RX] to input the frequency.
  - **Do not hold** [RX] for more than 0.5 sec., otherwise the frequency will be programmed into the channel.

### [EXAMPLE]: Setting 12.3450 MHz

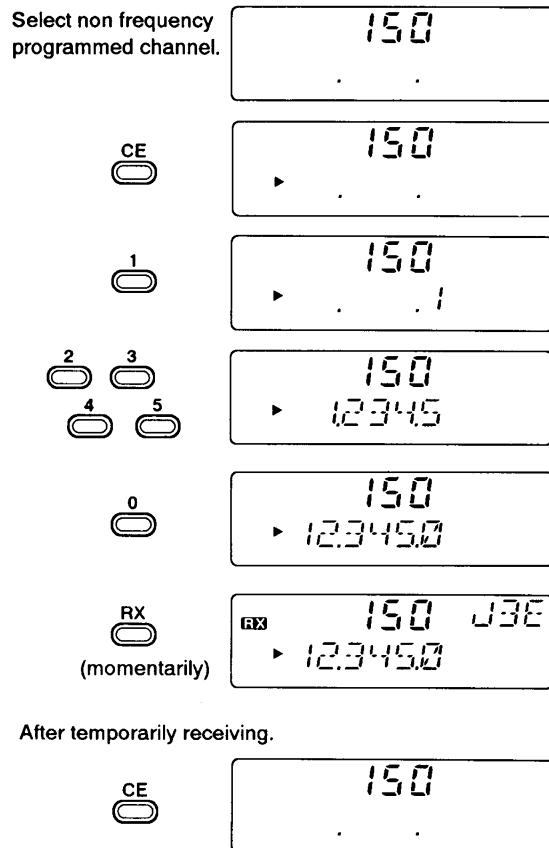

# 4 RECEIVE AND TRANSMIT

## Basic voice receive and transmit

- ① Be sure of the following in advance:
- Microphone is connected.
  - [SPEAKER] switch is turned OFF.
  - [SQL] switch is turned OFF.
  - [CLARITY] control is set to center position.

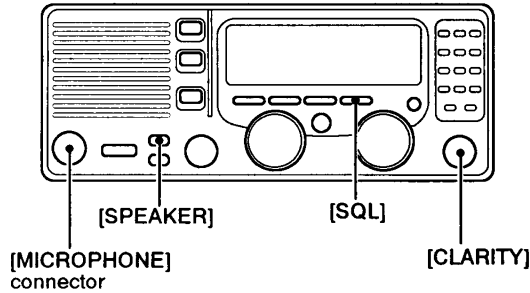

- ② Select the desired channel to be received with the [GROUP] and [CHANNEL] selectors.
- When receiving a signal, S-meter shows its signal strength.

- ③ Adjust [VOLUME] to the desired audio level when receiving a signal.
- ④ Push [MODE] to select the desired operating mode, if the received signal is in a different mode.
- ⑤ Push [TUNE] to tune the antenna tuner, if connected.
- This operation is not necessary when "automatic tuning" is selected in set mode (p. 12).
- ⑥ To transmit on the channel, push and hold the PTT switch on the microphone.
- "TUNE" flashes for 1 to 2 sec. for the first transmission on a channel when connecting an antenna tuner.
- ⑦ After the flashing stops, speak into the microphone at your normal voice level.
- The RF meter shows the output power (or antenna current) according to your voice level.
- ⑧ Release the PTT switch to return to receive.

## Functions for transmit

### ◇ Transmit frequency check

When "DUP" appears on the display such as for a ship-to-shore channel, the transmit frequency differs from the received frequency.

In such a case, the transmit frequency should be monitored before transmitting to prevent interference to other stations.

- Push and hold the [TX FREQ] switch to monitor the transmit frequency.
- The display shows the transmit frequency simultaneously.

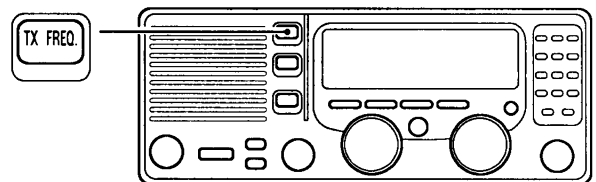

### ◇ Transmit power selection

The transceiver has 3 selectable output powers.\* High power allows longer distance communications and low power reduces power consumption.

\*Only 2 selectable output powers are available with some versions. In this case, level 1 stands for 60 W (the same as level 2).

/// **NOTE:** Low power setting affects all channels except the 2182 kHz emergency channel.

/// **NOTE:** Power selection is not possible with GMDSS versions, only high power is available.

- ① Push [FUNC] then [TX] to call up the following display.

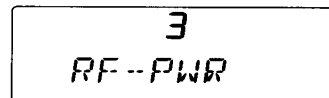

- ② Rotate the [CHANNEL] selector to select high or low output power.
- 3 : high power (150 W PEP)
  - 2 : middle power (60 W PEP)
  - 1 : low power (20 W PEP)
- ③ Push [FUNC] or [CE] to return to the previous display.

## Functions for receive

### ◇ Squelch function

This function detects signals with voice components and squelches (mutes) unwanted signals such as non modulated beat signals. This provides quiet stand by.

When you need to receive weak signals, the squelch should be turned OFF.

- Push [SQL] to turn the squelch function ON and OFF.

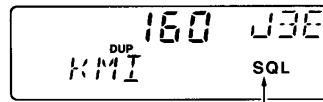

"SQL" appears when the squelch is ON (noise is muted).

### ◇ Noise blanker

The noise blanker function reduces pulse type noise such as that coming from engine ignitions.

The noise blanker may distort reception of strong signals. In such cases, the noise blanker should be turned OFF.

- Push [NB] to turn the noise blanker function ON and OFF.

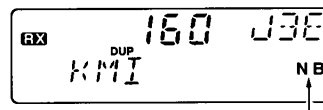

"NB" appears when the noise blanker is ON.

### ◇ AGC off function

The receiver gain is automatically adjusted according to received signal strength with the AGC (Automatic Gain Control) function to prevent distortion from strong signals and to obtain a constant output level.

When receiving weak signals with adjacent strong signals or noise, the AGC function may reduce the sensitivity. In this situation, the AGC function should be deactivated.

- Push [AGC] to deactivate or activate the AGC function.

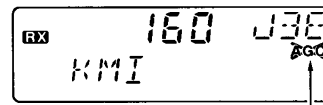

Appears when the [AGC] switch is ON (AGC function deactivates).

### ◇ RF gain setting

The receiver gain can be reduced with the RF gain setting. This may help to remove undesired weak signals while monitoring strong signals.

Usually, the AGC function reduces the RF gain according to the receive signal strength and these weak signals are removed. However, during periods of no signals, these weak signals may not be heard.

In such cases, the RF gain may be useful for setting a minimum level at which to hear signals.

- ① Push [FUNC] then [RX] to call up the following display.

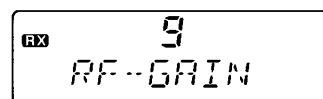

- ② Rotate the [CHANNEL] selector to set the desired minimum cutting level.
  - "0" to "9" are available.
  - S-meter shows the minimum permitted level.
- ③ Push [FUNC] or [CE] to exit the RF gain display.

### ◇ Clarity control

Voice signals received from other stations may be difficult to receive. This may sometimes happen if a station is transmitting slightly off frequency. In such cases, compensate the receive frequency only, using the [CLARITY] control.

- Adjust [CLARITY] to improve the audio signal.

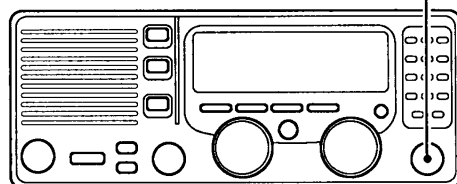

### ■ CW operation (Marine/General versions only)

The transceiver has the following CW keying features and they can be selected in set mode as described on p. 14

- Full break-in (receiving is possible while transmitting)
- Delay keying (automatic transmission with keying)
- OFF (manual transmission is necessary before keying)

- ① Connect a CW keyer or an external electronic keyer to the ACC(1) socket as shown at right.
- ② Select the desired channel to operate CW mode.
- ③ When the selected channel is not in A1A mode, push [MODE] one or more times to select "A1A."
- ④ Operate the CW keyer to transmit a CW signal.

/// CW mode may not be used depending on versions.  
 /// CW narrow can be selected in set mode (p. 13) when an optional filter is installed (already built-in to the GMDSS versions).

CW key connection

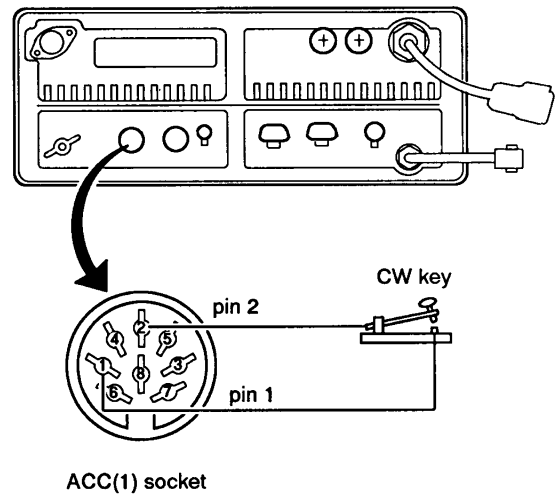

### ■ FSK operation (Marine/General versions only)

The transceiver has FSK and J2B modes for FSK operation. Use the FSK mode when using the oscillator in the transceiver and use the J2B mode when using an AFSK terminal unit.

- ① Connect an FSK terminal unit as shown at right.
- ② Select the desired channel.
  - FSK ITU channel group, ch 4001 to ch 25040, are available depending on versions.
- ③ Push [MODE] one or more times to select the type of emission as "FSK" or "J2B."
- ④ Operate the FSK terminal unit.

/// FSK shift frequency and FSK polarity can be adjusted in set mode (pgs. 13, 14).

**NOTE:** Some transceivers may operate 1.7 kHz higher than the IC-M710's J2B mode even when the same displayed frequencies are in use.

FSK terminal unit connection

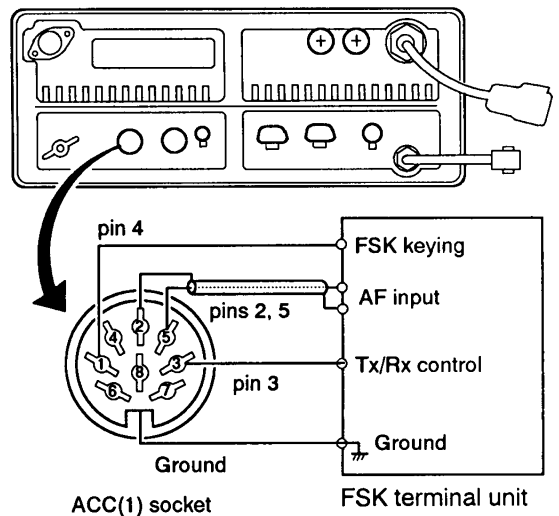

### ■ Cross channel operation (Europe versions only)

Cross channel operation is available with some versions to operate different channels for receiving and transmitting.

- ① Select the desired channel for receiving.
  - ITU simplex channels cannot be used for cross channel operation.
- ② Push [TX], then select the desired channel for transmitting.
  - "[TX]" blinks after pushing [TX].
- ③ Push [TX] again to stop the blinking.
- ④ Operate the transceiver normally.
- ⑤ Change the channel to clear the cross channel setting.

Cross channel operation example

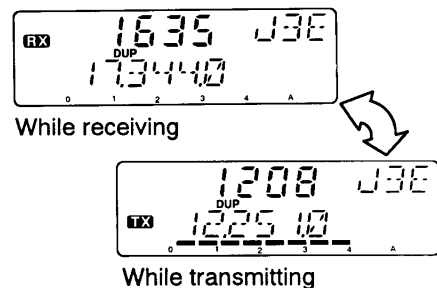

/// **NOTE:** This function is available for the Europe versions only.

## Programming a frequency

The IC-M710 has up to 160 user-programmable channels each with channel name capability of up to 7 alphanumeric characters.

**NOTE:** ITU simplex channels can be programmed as well as user channels. However, transmit frequencies cannot be programmed (not necessary to program).

### Receive frequency

- ① Select the desired user channel to be programmed.
  - Channels 1 to 160 (maximum) are programmable.
- ② Push [CE] to select frequency selection mode.
  - "▶" and frequency appear on the display.
- ③ Enter the desired frequency via the keypad with 5 or 6 digits.
  - Or rotate the [CHANNEL] selector to change the frequency.
- ④ To change the operating mode (type of emission), push [MODE] one or more times.
- ⑤ Push and hold [RX] for 1 sec. to program the user channel.

Push [CE]

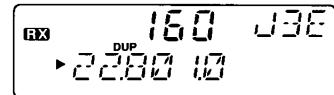

Frequency and "▶" appear.

Set frequency.

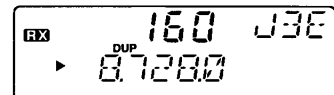

Use keypad or channel selector.

Push and hold [RX].

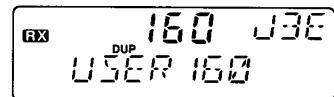

Programming is completed.

### Transmit frequency (Not applicable for General versions)

- ① Select the desired user channel to be programmed.
- ② Push [TX].
  - "TX" blinks.
- ③ Push [CE] to select frequency selection mode.
  - "▶" and frequency appears on the display.
- ④ Enter the desired frequency via the keypad with 5 or 6 digits.
  - The [CHANNEL] selector cannot be used.
  - Refer to p. 23 for programmable frequency range (frequency coverage, transmit).
- ⑤ Push and hold [TX] for 1 sec. to program.
- ⑥ Push [TX] to clear the "TX" blinking.

Push [TX].

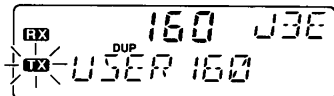

"TX" blinks.

Push [CE]

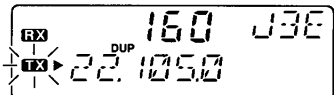

Push and hold [TX] after entering a frequency.

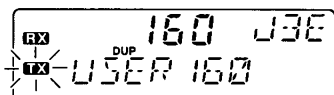

### Channel name

- ① Select the desired user channel to be programmed.
- ② Push [CH/FREQ] to select channel indication.
- ③ Push [FUNC] then [CE].
  - The channel name (alphanumeric) readout blinks.
- ④ Rotate the [GROUP] selector for cursor position and the [CHANNEL] selector for the message contents.
  - To return to the previous message, push [CE].
- ⑤ Push and hold [RX] to program the message.
  - Blinking stops.

Push [FUNC] then [CE]

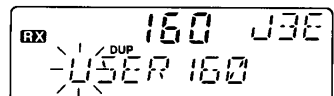

Rotate [GROUP] and [CHANNEL] to select cursor and character.

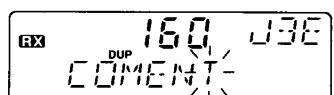

Push [RX].

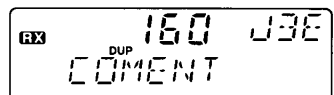

• Available characters

0 to 9 A to Z \_ (space)  
, ( ) \* + - / : = > @

Channel name programming is inhibited on some versions.

# 6 SET MODE

## Set mode operation

Set mode operation is used for programming infrequently changed values or conditions of functions. The IC-M710 has up to 13 such items.

Some of the set mode items described in this section are not available on some transceiver versions.

- ① Push [POWER] to turn power OFF.
- ② While pushing and holding [FUNC] and [1], turn power ON to enter set mode.
  - Set mode is selected and one of its items appears.
- ③ Rotate the [GROUP] selector to select the desired item.
- ④ Rotate the [CHANNEL] selector to set the values or conditions for the selected item.
- ⑤ Turn power OFF and ON again to exit set mode.

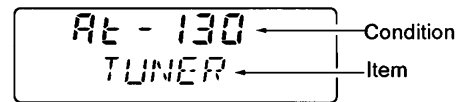
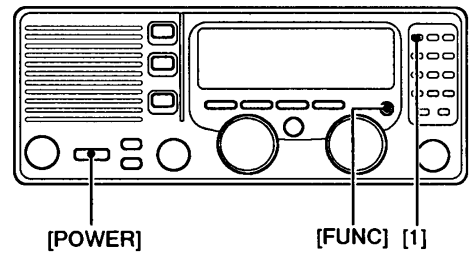

## Set mode contents

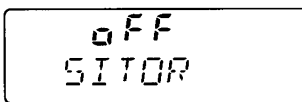
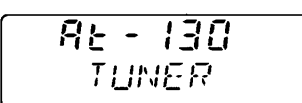
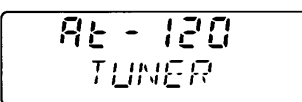
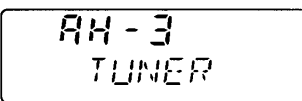
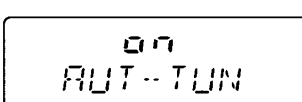
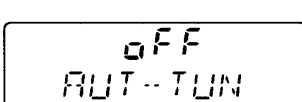
<p><b>(1) FSK ITU channels</b> FSK ITU channels appear as a group between the ITU 25 MHz band and user channels. This FSK channel group can be hidden for voice communication use only.</p>		<p>FSK channels do not appear (no SITOR operation). <i>(default)</i></p>
<p><b>(2) Connected antenna tuner</b> The transceiver has several tuner control systems for use with an optional Icom antenna tuner. Select the condition depending on the connected antenna tuner.</p> <p>Note that internal switch selection may be required when using a non-Icom tuner (p. 19).</p>	  	<p>AT-130 <i>(default)</i></p> <p>AT-120</p> <p>AH-3</p>
<p><b>(3) Automatic tuning condition</b> When the optional AT-130 or AT-130E AUTOMATIC ANTENNA TUNER is connected, tuning can be started automatically without the [TUNE] switch for instant operation.</p> <p>If manual tuning is required, this automatic operation can be deactivated.</p>	 	<p>Tuning starts when pushing [PTT] on a new frequency.</p> <p>Tuning starts only when [TUNER] is pushed. <i>(default)</i></p>



**(4) Scan type selection (scan-type only)**

This item selects one of the following scan functions.

Channel scan and channel resume scan search 5 channels around a user selected channel or search all ITU channels in the band when an ITU channel is selected.

Programmed scan (optional) searches signals within the frequency range and activates slowly while squelch is open and fast while squelch is closed.

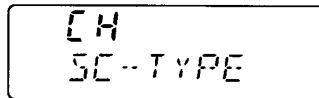

Channel scan  
Scan is canceled when transmitting.  
*(default)*

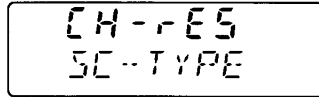

Channel resume scan  
Scan pauses when transmitting, then resumes after 30 sec.

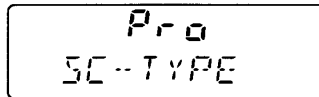

Programmed scan  
Scan operates over the frequency range.  
*(optional)*

**(5) Scan speed (scan type only)**

Selects scan speed as follows:

Selection	1	2	3	4	5	6	7	8	9	10
Channel scan	130	260	520	1040	2080	4160	8320	16460	33280	66560
Channel resume scan (sec./ch)	1	2	3	4	5	6	7	8	9	10
Programmed scan (squelch open*)	10	20	40	60	90	140	210	320	480	720

\*squelch closed: 10 ms/ch      ←Fast speed                      Slow speed →

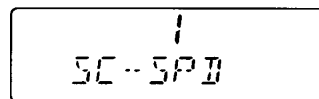

Fastest scan speed

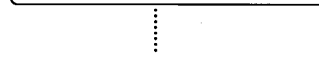

*(default: 4)*

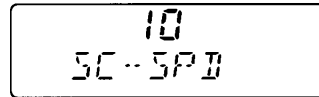

Slowest scan speed

**(6) Channel name and frequency**

The lower half of the display can be set to display a programmable channel name or a receive frequency according to an operator's needs.

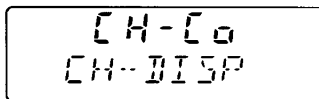

Channel number and channel name (alphanumeric)  
*(default)*

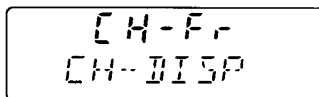

Channel number and frequency

**(7) CW/FSK narrow filter**

This item selects the passband width for A1A (CW), FSK or J2B mode.

**NOTE:** When "on" is selected without optional filter installation, the Marine and General versions do not function on these modes. The GMDSS versions can use "on" as standard.

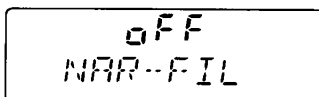

Passband:  
2.3 kHz/-6 dB  
*(default)*

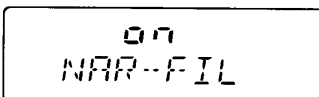

Passband:  
500 Hz/-6 dB  
(for General/Marine ver.)  
350 Hz/-6 dB  
(for GMDSS versions)

**(8) FSK shift frequency**

Several shift frequencies (the difference between the mark and space frequency) are used for FSK operation. This item allows you to select a shift frequency for almost any FSK system.

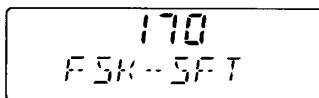

Shift frequency:  
170 Hz  
*(default)*

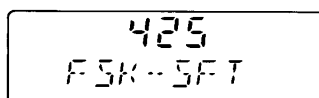

Shift frequency:  
425 Hz

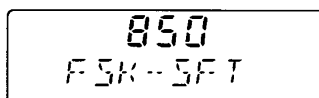

Shift frequency:  
850 Hz

## 6 SET MODE

### (9) FSK polarity

Normal and reverse polarities are available for FSK operation. This item allows you to select one of these polarities.

"FSK-REV off" (normal):

key open (mark); key close (space)

"FSK-REV on" (reverse):

key open (space); key close(mark)

off  
FSK-REV

FSK normal  
(default)

on  
FSK-REV

FSK reverse

### (10) CW break-in

CW break-in function (in A1A mode) toggles transmit and receive with CW keying. Full break-in allows you to receive signals between transmitted keying pulses during CW transmission. Semi break-in allows you to mute receiving until keying stops with some delay time.

FULL  
CW-BKIN

Full break-in  
Automatic keying without  
delay time  
(default)

DELAY  
CW-BKIN

Semi break-in  
Automatic keying with  
delay time

off  
CW-BKIN

OFF  
Manual transmission  
necessary for keying

### (11) LCD contrast

The LCD contrast can be adjusted through 10 levels to suit transceiver mounting angle, location and ambient lighting.

01  
LCD-ENT

Lowest contrast

⋮

(default: 7)

10  
LCD-ENT

Highest contrast

### (12) ID number setting for remote control

When connecting an external controller such as a personal computer, 2-digit ID codes are required to access the transceiver. The IC-M710 adopts NMEA0183 format and uses a "proprietary sentence" for remote control.

01  
REMT-ID

NMEA ID: "01"  
(default)

⋮

99  
REMT-ID

NMEA ID: "99"

### (13) Remote control input terminal

Remote control signals can be input via the [DSC] (or REMOTE) socket or [CLONE] jack.

d-Sub  
REMT-IF

[DSC] (or REMOTE  
according to version)  
socket  
(default)

Pin  
REMT-IF

[CLONE] jack

## Connections on rear panel

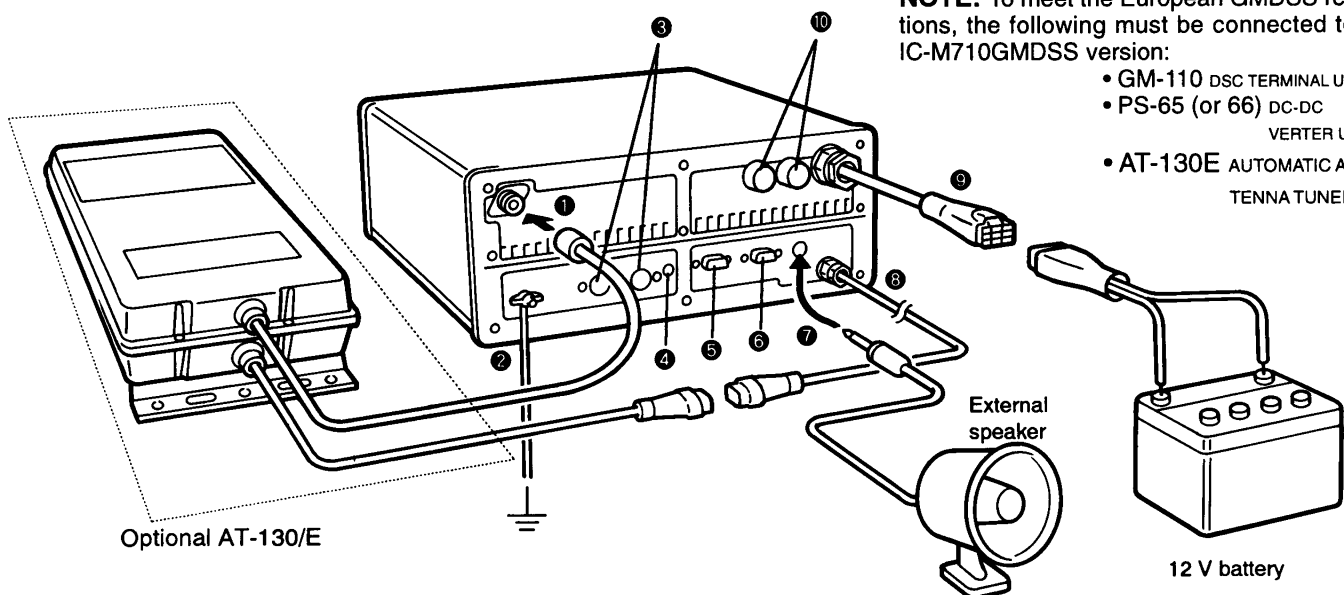

**NOTE:** To meet the European GMDSS regulations, the following must be connected to the IC-M710GMDSS version:

- GM-110 DSC TERMINAL UNIT
- PS-65 (or 66) DC-DC CONVERTER UNIT
- AT-130E AUTOMATIC ANTENNA TUNER

- 1 ANTENNA CONNECTOR** (p. 19)  
Connects a 50 Ω HF band antenna with a 50 Ω matched coaxial cable and a PL-259 plug.
- 2 GROUND TERMINAL** (p. 18)  
*IMPORTANT!* Connects a ship's (or vehicle's) ground. See p. 18 for details.
- 3 ACC(1) and ACC(2) SOCKETS**  
See p. 16 for details
- 4 CLONE JACK**  
For Dealer use only.
- 5 DSC or REMOTE SOCKETS**
  - DSC socket for GMDSS versions — Connects an optional GM-110DSC DSC TERMINAL UNIT for DSC operation.
  - REMOTE socket for Marine and General versions.
- 6 MOD/AF SOCKET** (GMDSS versions only)  
Connects an external terminal unit.

- 7 EXTERNAL SPEAKER JACK**  
Connects a 4–16 Ω external speaker using a 1/4 inch monaural plug. This external audio is not muted by the [SPEAKER] switch on the front panel.
- 8 TUNER RECEPTACLE**  
Connects a control cable to an optional AT-130 or AT-130E ANTENNA TUNER. A female connector is supplied for connection.
- 9 DC POWER RECEPTACLE**  
Connects to a regulated 12–16 V DC power source such as 12 V battery or DC power supply using the supplied DC power cable.  
**CAUTION: DO NOT** connect to a 24 V battery. This will damage the transceiver.
- 10 FUSE HOLDERS**  
Hold two 30 A fuses for ⊕ and ⊖ terminals. Replace both fuses when one fuse is blown.

## Unpacking

Microphone (EM-101)* . . . . . 1	DIN connector (7-pin for ACC2) . . . . . 1	Nuts (M6; use 2 pcs. for each bolt) . . . . 8
Microphone hanger . . . . . 1	Speaker plug (5610000040) . . . . . 1	Flat washers (M6) . . . . . 8
DC power cable (OPC-568) . . . . . 1	Tuner connector (56100000150) . . . . . 1	Spring washers (M6) . . . . . 4
Mounting bracket . . . . . 1	Pins for tuner connector (6510019030) . 4	Self-tapping screws (3.5 × 30 for mic. hanger) . . . . . 2
Bracket knobs (8820000170) . . . . . 4	DIN connector cover (GMDSS only) . . . 1 (attach to the ACC sockets)	
*Some versions have no microphone supplied.		
<b>CONNECTORS</b>	<b>NUTS AND BOLTS</b>	<b>FUSES</b>
DIN connector (8-pin for ACC1) . . . . . 1	Allen bolt (M6 × 50) . . . . . 4	FGB 30 A (for rear panel) . . . . . 2
	Self-tapping screws (M6 × 30) . . . . . 4	FGB 5 A (for inside) . . . . . 2

## Connector information

ACC(1)*	PIN	PIN NAME	DESCRIPTION	SPECIFICATIONS
 <p>Rear panel view</p>	1	CWK	CW and FSK keying input.	Input level : Less than 0.6 V for transmit
	2	GND	Connects to ground.	Connected in parallel with ACC(2) pin 2.
	3	SEND	Input/output pin. Goes to ground when transmitting. When grounded, transmits.	Ground level : -0.5 to 0.8 V Input current : Less than 20 mA Connected in parallel with ACC(2) pin 3.
	4	MOD	Modulator input. Usable when pin 3 is grounded.	Input impedance : 10 kΩ Input level : Approx. 100 mV rms.
	5	AF	AF detector output. Fixed, regardless of [AF] position.	Output impedance : 4.7 kΩ Output level : 100 - 300 mV rms
	6	SCAN	Starts scan when grounded.	Scan operation : Less than 0.6 V
	7	13.6 V	13.6 V output when power is ON.	Output current : Max. 1 A Connected in parallel with ACC(2) pin 7.
	8	ALC	ALC voltage input.	Control voltage : -3 to 0 V Input impedance : More than 10 kΩ Connected in parallel with ACC(2) pin 5.

\* ACC(1): Marine and general version only.

ACC(2)*/ACC*	PIN	PIN NAME	DESCRIPTION	SPECIFICATIONS
(Marine/General versions)  <p>Rear panel view</p>	1	8 V	Regulated 8 V output.	Output voltage : 8 V ± 0.3 V Output current : Less than 10 mA
	2	GND	Same as ACC(1) pin 2.	
	3	SEND	Same as ACC(1) pin 3.	
	4	NC	No connection	
	5	ALC	Same as ACC(1) pin 8.	
	6	RLC	T/R relay control output	When transmitting : 0 V (less than 0.5 A)
	7	13.6 V	Same as ACC(1) pin 7.	

\* ACC(2): Marine and general version, ACC: GMDSS version.

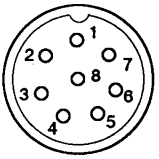
MICROPHONE	PIN	PIN NAME	DESCRIPTION	SPECIFICATIONS
	1	MIC+	Audio input from the microphone element.	Input impedance : 600 Ω
	2	NC	No connection	
	3	AF1	AF output controlled with [VOLUME]. Connected to pin 4 in the microphone.	Output impedance : 4 Ω
	4	AF2	AF input Connected to pin 3 in the microphone.	
	5	PTT	PTT switch input	When grounded, transmits.
	6	GND	Connected to ground.	
	7	MIC-	Coaxial ground for MIC+	
	8	AF-	Coaxial ground for AF1 and AF2.	

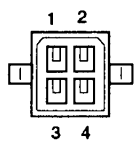
TUNER	PIN	PIN NAME	DESCRIPTION	SPECIFICATIONS
	1	KEY	Key signal input	- 0.5 to 0.8 V during tuning
	2	START	Start signal output	Pulled up 8 V, 0 V(100 msec.) as a start signal.
	3	13.6V	13.6 V output	Maximum current : 2 A
	4	E	⊖ terminal	For U.S.A. version (See below for Europe version)
		ANTC	Antenna current input	Input level : Approx. 2 Vrms

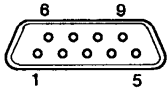
DSC	PIN	PIN NAME	DESCRIPTION	SPECIFICATIONS	
(GMDSS versions only)		1	DMD+	Modulation input from a DSC terminal unit	Input impedance : 600 Ω Input level : Approx. 0.75 V rms
		2	DMD-	Coaxial ground for DMD+	
		3	DAF+	AF detector output for a DSC terminal unit.	Output impedance : 600 Ω Output level : 0.25–2.5 Vrms
		4	DAF-	Coaxial ground for DAF+	
		5	NMI+	NMEA data input	NMEA standard format/level
		6	NMI-	Coaxial ground for NMI+	
		7	NMO+	NMEA data output	NMEA standard format/level
		8	NMO-	Coaxial ground for NMO+	
		9	GND	Ground for digital equipment	

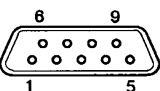
MOD/AF	PIN	PIN NAME	DESCRIPTION	SPECIFICATIONS	
(GMDSS version only)		1	NMD+	Modulation input from an external terminal unit.	Input impedance : 600 Ω Input level : Approx. 100 mV rms
		2	NMD-	Coaxial ground for NMD+	
		3	NAF+	AF detector output for an external terminal unit	Output impedance : 600 Ω Output level : 0.25–2.5 Vrms
		4	NAF-	Coaxial ground for NAF+	
		5	NSEN	Transmits when grounded	Ground level : - 0.5 to 0.8 V Input level : Less than 20 mA
		6	NC	No connection	
		7	NC	No connection	
		8	NC	No connection	
		9	GND	Ground for digital equipment	

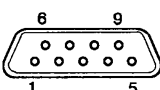
REMOTE	PIN	PIN NAME	DESCRIPTION	SPECIFICATIONS	
(Marine/General versions)		1	MOD+	Modulation input from an external terminal unit	Input impedance : 600 Ω Input level : Approx. 100 mV rms
		2	MOD-	Coaxial ground for MOD+	
		3	AF+	AF detector output for an external terminal unit.	Output impedance : 600 Ω Output level : 0.25–2.5 Vrms
		4	AF-	Coaxial ground for AF+	
		5	NMI+	NMEA data input	NMEA standard format/level
		6	NMI-	Coaxial ground for NMI+	
		7	NMO+	NMEA data output	NMEA standard format/level
		8	NMO-	Coaxial ground for NMO+	
		9	GND	Ground for digital equipment	

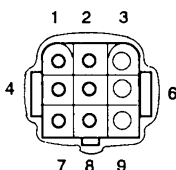
DC 13.6V	PIN	PIN NAME	DESCRIPTION	SPECIFICATIONS
	1,4,7	⊕	DC input ⊕	Max. power consumption: 30 A
	2,5,8	⊖	DC input ⊖	

## Ground connection

The transceiver and antenna tuner **MUST** have an adequate ground connection. Otherwise, the overall efficiency of the transceiver and antenna tuner installation will be reduced. Electrolysis, electrical shocks and interference from other equipment could also occur.

For best results, use the heaviest gauge wire or strap available and make the connection as short as possible. Ground the transceiver and antenna tuner to one ground point, otherwise voltage differences between 2 ground points may cause electrolysis.

**CAUTION:** The IC-M710 has either a negative ground or floating ground depending on version. **NEVER** connect the negative ground type to a "plus-grounding ship" otherwise the transceiver will not function.

### Ground system example

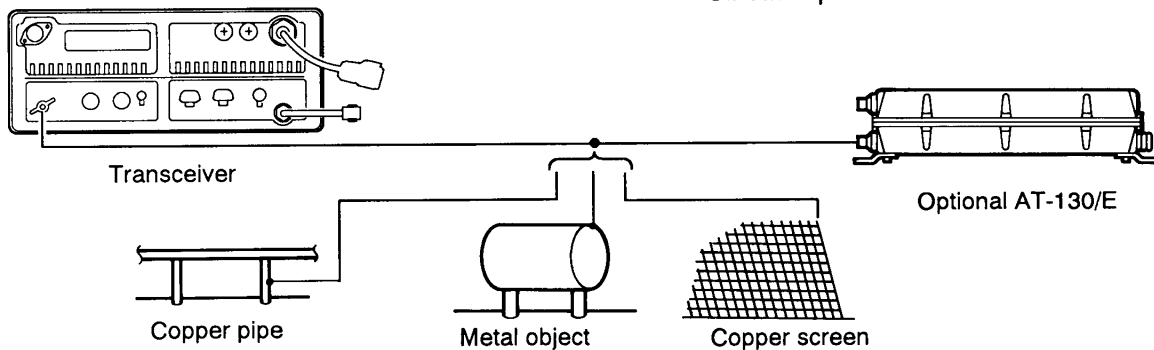

### Good ground points

- Ship's ground terminal
- External ground plate
- External copper screen

### Acceptable ground points

- Stainless steel tuna tower
- Stainless steel stanchion
- Through mast
- Through hull
- Metal water tank

### Undesirable ground points

- (these points may cause noise or electrolysis)
- Engine block
  - Keel bolt

### Unusable points

- (these connection may cause an explosion or electrical shock)
- Gas or electrical pipe
  - Fuel tank
  - Oil-catch pan

## Power source

The transceiver requires regulated DC power of 13.6 V and at least 30 A. There are 3 ways to supply power:

- Direct connection to a 12 V battery in your ship through the supplied DC power cable.
- Use the PS-60 DC POWER SUPPLY to connect to an AC outlet.
- Use the PS-66 DC-DC CONVERTER to connect to a 19-32 V DC power source.

**CAUTION:** The supplied DC power cable **MUST** be used to provide power to the transceiver. **AVOID** exceeding the 3 m (10 ft.) length of the DC power cable. If it is necessary to make a run of over 3 m, use #6 or similar cable instead of the supplied DC power cable for a maximum run of 6 m (20 ft.)

### DC power cable connection

**NOTE:** Use terminals for the cable connection.

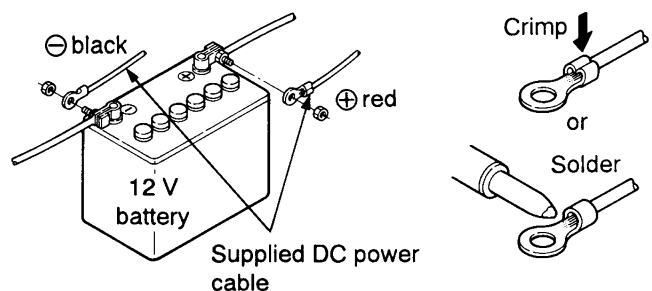

## Antenna

Most stations operate with a whip or long wire (insulated backstay) antenna. However, these antennas cannot be connected directly to the transceiver since their impedance may not be matched with the transceiver antenna connector.

With a 50 Ω matched antenna all marine bands cannot be used. The following antenna matcher or antenna tuner may be helpful for antenna installation.

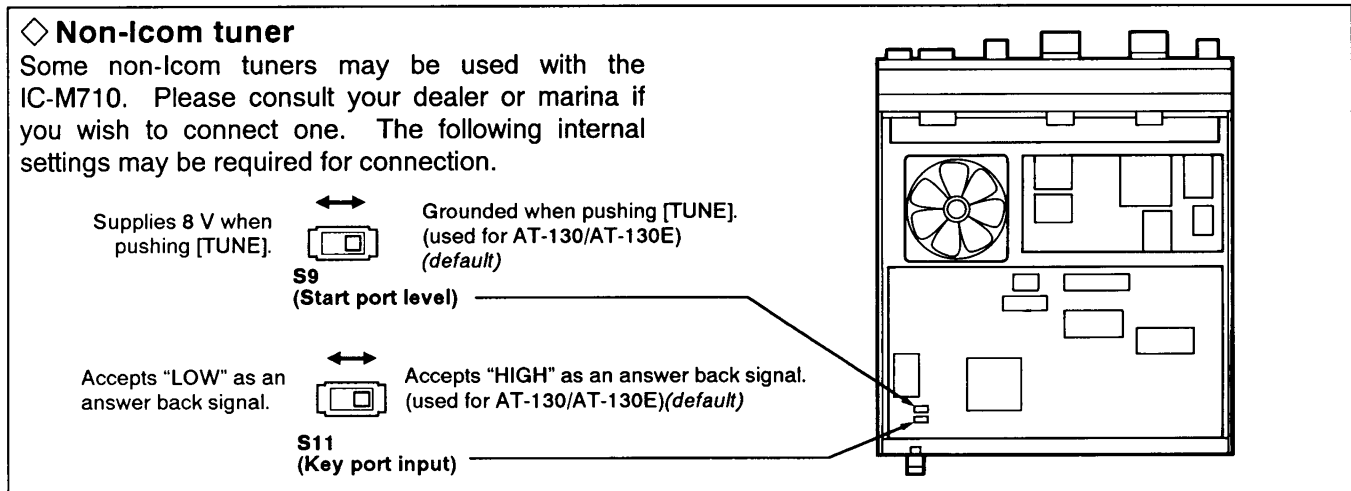
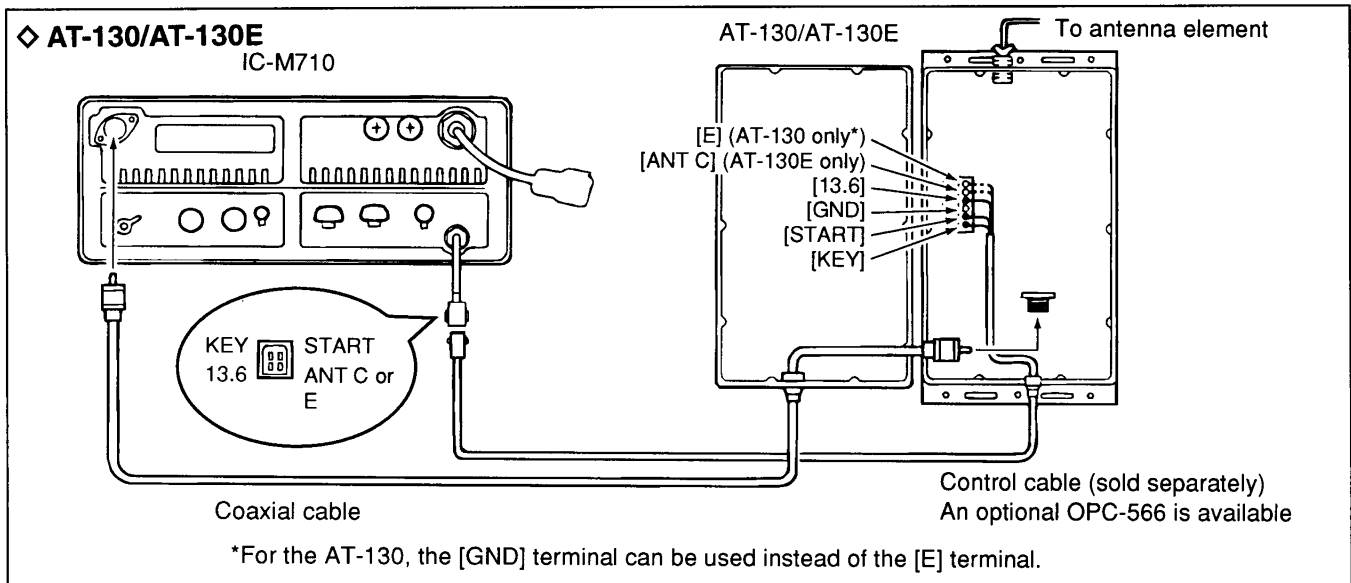
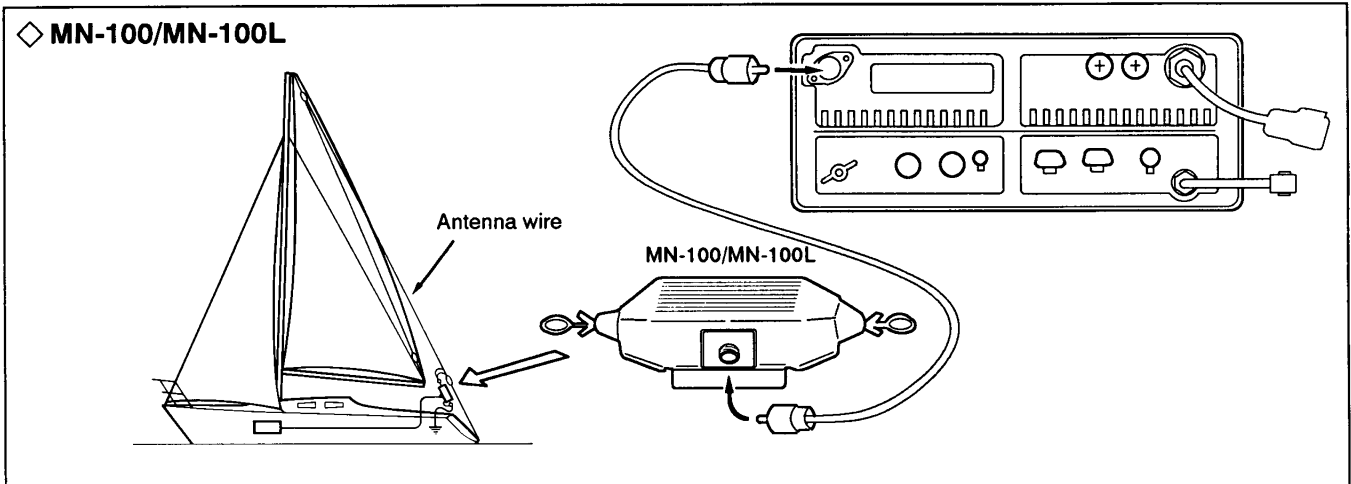

## ■ Mounting

**⚠ WARNING: NEVER** mount the transceiver overhead. The weight of the transceiver is approximately 8 kg, but its apparent weight will increase several fold due to wave shocks or vibration. The transceiver must be mounted on a flat, hard surface.

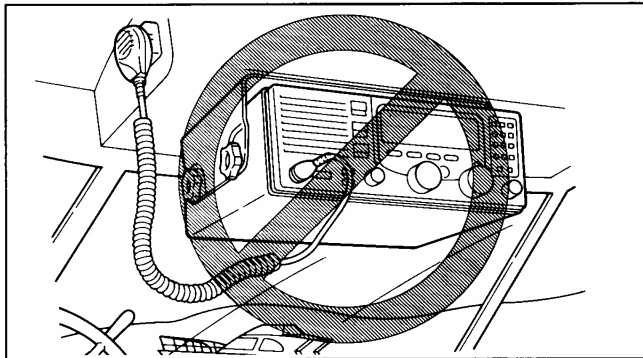

### ◇ Mounting location

Select a location that provides easy access to the front panel for navigation safety, has good ventilation and is not subject to sea spray. The face of the transceiver should be at 90 degrees to your line of sight when operating it.

**CAUTION: KEEP** the transceiver and microphone at least 1 meter away from your vessel's magnetic navigation compass.

Check the installation angle; the display may not be easy-to-read at some angle.

### ◇ Mounting example

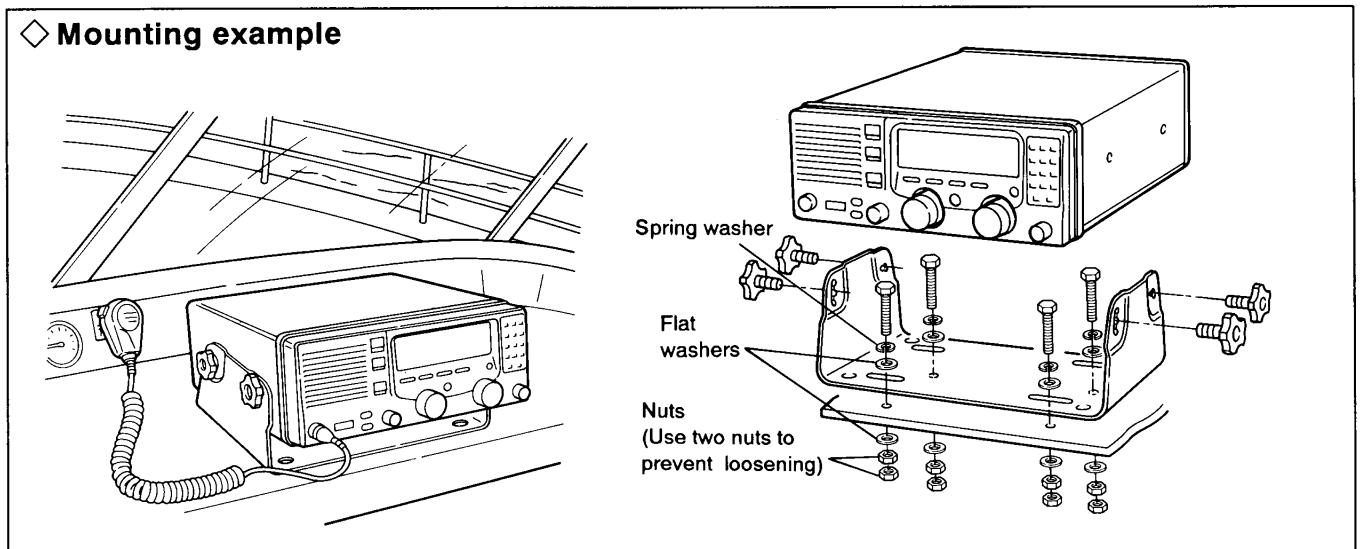

### ◇ Transceiver dimensions

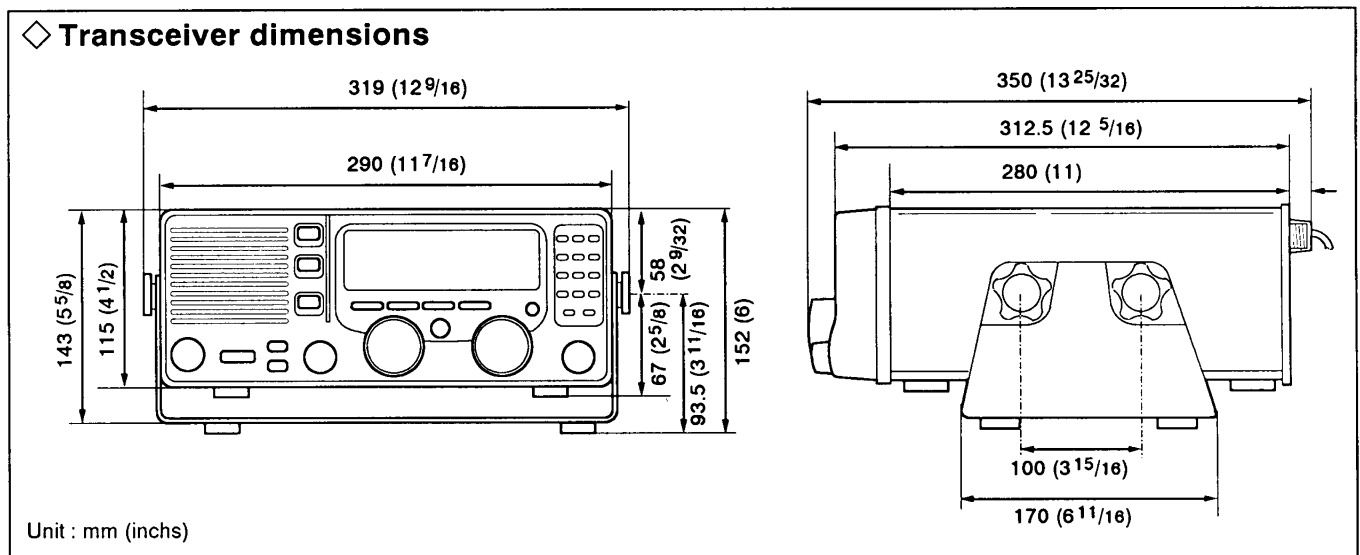



## ■ Installing options

### ◇ Opening the case

Follow the case and cover opening procedures shown here when you want to install an option or adjust a setting for non-Icom tuner control.

- ① Remove 9 screws from the rear panel, then remove the rear frame and rear sealing.
- ② Remove the transceiver's case as shown at right.
- ③ When reassembling the cover, check the following points:
  - Internal fan and slits in the case are on the same side.
  - Mate the front sealing correctly.
  - Attach the rear sealing in the correct direction.
  - Tighten the screws to their previous positions.

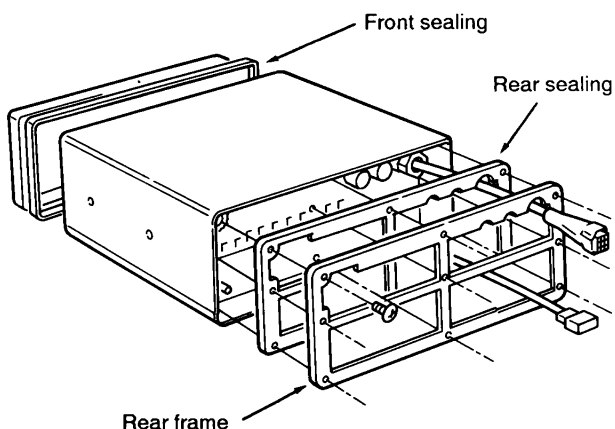

### ◇ Installing an optional filter and alarm unit

After opening the case as above, install the desired option to the position as at right.

These options are available (or already built-in) for the following versions:

Version	GMDSS	Marine	General
<b>FL-100</b> CW/FSK narrow filter	different filter built-in	optional	optional
<b>UT-95</b> 2-tone alarm unit	built-in	built-in	optional

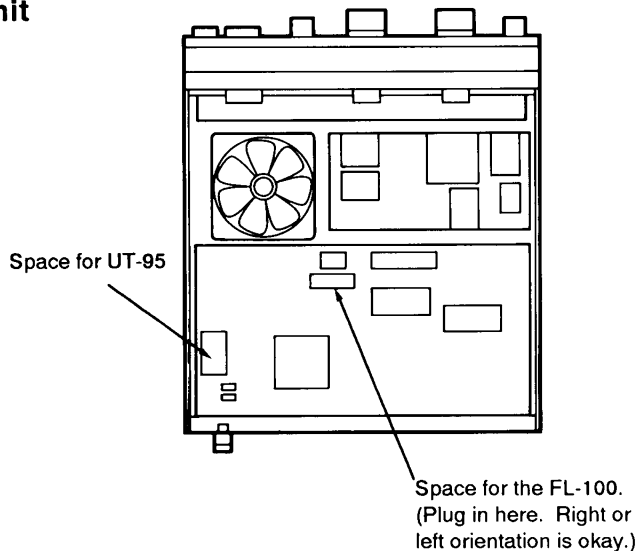

After installing the 2-tone alarm unit into a General version, remove the plastic cover on the [ALARM] switch to use the switch.

## ■ Fuse replacement

The transceiver has 3 fuses to protect internal circuitry, 2 fuses for the fuse holder on the rear panel and 1 for inside. If the transceiver stops functioning, check the fuses below.

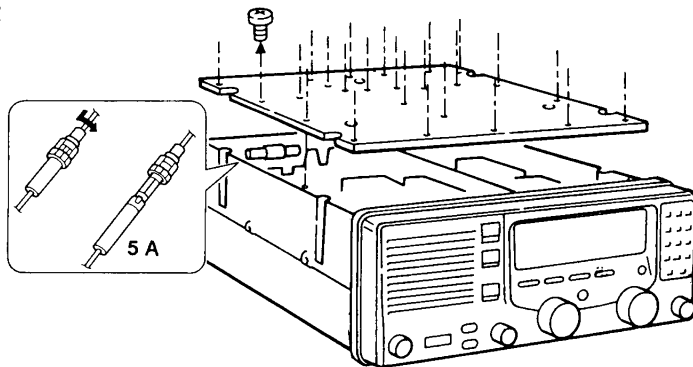
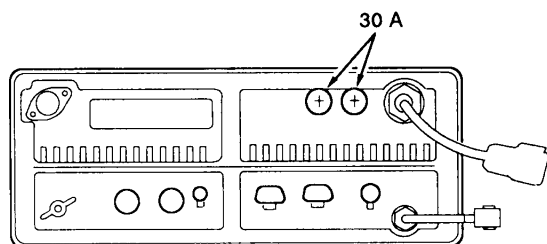

# 8

# TROUBLESHOOTING

What appears to be trouble may not be damaging or hard to solve. Check the following chart before making any adjustments or sending the transceiver to an Icom Service center.

	PROBLEM	POSSIBLE CAUSE	SOLUTION	REF.
<b>POWER</b>	Power does not come on when [POWER] is pushed.	<ul style="list-style-type: none"> <li>• Power cable is improperly connected.</li> <li>• Blown fuse.</li> </ul>	<ul style="list-style-type: none"> <li>• Reconnect the cable securely.</li> <li>• Check for cause, then replace the fuse with a spare one.</li> </ul>	p. 15 p. 21
<b>RECEIVE</b>	No sound comes from the speaker.	<ul style="list-style-type: none"> <li>• The [SPEAKER] switch is turned ON.</li> <li>• Microphone is not connected.</li> <li>• RF gain is set too deeply and several segments of the S-meter appear.</li> <li>• The squelch is closed.</li> </ul>	<ul style="list-style-type: none"> <li>• Turn OFF the [SPEAKER] switch.</li> <li>• Connect the microphone to the [MICROPHONE] connector.</li> <li>• Push [FUNC], then [RX] to reset the RF gain. (RF GAIN 9 applies audio.)</li> <li>• Push [SQL] switch to turn the squelch OFF.</li> </ul>	p. 2 p. 2 p. 9 p. 9
	Sensitivity is low and only strong signals are audible.	<ul style="list-style-type: none"> <li>• Antenna is not properly matched to the operating frequency.</li> <li>• RF gain is set too deeply.</li> <li>• Wrong tuner condition is selected in set mode.</li> </ul>	<ul style="list-style-type: none"> <li>• Push [TUNE] to tune the connected antenna tuner or select "automatic tuning" using set mode when an optional AT-130/E is connected.</li> <li>• Push [FUNC], then [RX] to reset the RF gain.</li> <li>• Set to the proper condition for the connected tuner.</li> </ul>	p. 12 p. 9 p. 12
	Received audio is unclear or distorted.	<ul style="list-style-type: none"> <li>• Wrong type of emission is selected.</li> <li>• AGC is deactivated while receiving a strong signal.</li> <li>• Noise blanker is turned ON when receiving a strong signal.</li> <li>• The [CLARITY] control is rotated too far clockwise or counterclockwise.</li> </ul>	<ul style="list-style-type: none"> <li>• Push [MODE] to select the proper operating mode.</li> <li>• Push [AGC] to activate the AGC function.</li> <li>• Push [NB] to turn the noise blanker OFF.</li> <li>• Adjust the [CLARITY] control to receive proper audio output.</li> </ul>	p. 8 p. 9 p. 9 p. 9
<b>TRANSMIT</b>	Your signal does not reach as far away as usual.	<ul style="list-style-type: none"> <li>• The transmit power is set low.</li> <li>• Antenna tuner is improperly matched to the operating frequency when manual tuning is selected.</li> <li>• CW or FSK mode is selected for voice transmission.</li> </ul>	<ul style="list-style-type: none"> <li>• Push [FUNC], then [TX] to reset the transmit power. (RF-PWR 3 is maximum power.)</li> <li>• Push [TUNE] to tune the connected antenna tuner or select "automatic tuning" using set mode.</li> <li>• Push [MODE] to select J3E mode (or H3E, R3E etc.)</li> </ul>	p. 8 p. 8 or p. 12 p. 8
	Transmit signal is unclear or distorted.	<ul style="list-style-type: none"> <li>• Wrong type of emission is selected.</li> <li>• Microphone is too close to your mouth.</li> </ul>	<ul style="list-style-type: none"> <li>• Push [MODE] to select the proper operating mode.</li> <li>• Speak into the microphone naturally and do not hold the microphone too close to your mouth.</li> </ul>	p. 8 —
	No contact is possible with another station.	<ul style="list-style-type: none"> <li>• Wrong transmit frequency is set.</li> </ul>	<ul style="list-style-type: none"> <li>• Push [TX FREQ] to check and store the correct transmit frequency.</li> </ul>	p. 8
<b>DISPLAY</b>	Frequency cannot be set via the keypad.	<ul style="list-style-type: none"> <li>• The [CE] key is not pushed ("▶" does not appear) before digit entry.</li> <li>• 2182 kHz is selected with the [2182KHz] switch.</li> </ul>	<ul style="list-style-type: none"> <li>• Push [CE] ("▶" appears), then enter the desired frequency.</li> <li>• Push [2182KHz], then set the frequency.</li> </ul>	p. 7 p. 5
	All indicators appear and the channel number cannot be read.	<ul style="list-style-type: none"> <li>• The highest contrast is selected in set mode.</li> </ul>	<ul style="list-style-type: none"> <li>• Set to the proper display contrast.</li> </ul>	p. 14
	FSK ITU channels cannot be selected.	<ul style="list-style-type: none"> <li>• SITOR operation is set to OFF in set mode.</li> </ul>	<ul style="list-style-type: none"> <li>• Set "SITOR" to ON in set mode.</li> </ul>	p. 12

## Specifications

### General

- Frequency coverage
 

Receive	500 kHz – 29.999 MHz
Transmit	1.6 – 2.9999 MHz, 4.0 – 4.9999 MHz 6.0 – 6.9999 MHz, 8.0 – 8.9999 MHz 12.0 – 13.9999 MHz, 16.0 – 17.9999 MHz 18.0 – 19.9999 MHz, 22.0 – 22.9999 MHz 25.0 – 27.5000 MHz
- Mode : J3E(USB), H3E, J2B(AFSK), F1B(FSK), R3E, A1A(CW)  
(available modes differ depending on version)
- Number of channels : 1136 channels (max.)
 

(160 (user programmable) 242 (ITU SSB duplex), 72 (ITU SSB simplex) 662 (ITU FSK duplex))
---
- Antenna impedance : 50 Ω nominal
- Usable temperature range : -30 to +60°C; (-22 to +140°F)
- Frequency stability : ±10 Hz (-30 to +60°C; -22 to +140°F)  
(±20 Hz above 15 MHz for General and Marine versions)
- Power supply requirement : 13.6 V DC ± 15%  
(negative and floating grounds are available depending on versions)
- Current drain:
 

Transmit (max. output power)	30 A
Receive (max. audio output)	2.5 A (negative ground type) 3 A (floating ground type)
- Dimensions : 291.4(W) × 116.4(H) × 315(D) mm  
11.3(W) × 4.4(H) × 12.8(D) in  
(projections not included)
- Weight : 7.9 kg; 17.4 lb (negative ground type)  
8.1 kg; 17.9 lb (floating ground type)

### Transmitter

- Output power :
 

U.S.A. versions	150, 60, 20 W PEP (selectable) (60, 20 W only for 25 MHz band)
Europe versions	150, 60 W PEP (selectable) (60 W only for 25 MHz band)
GMDSS versions*	125 W PEP (85 W PEP for MF and 25 MHz bands)
  - Spurious emissions : -65 dB (U.S.A. versions)  
-60 dB (Europe versions)
  - Carrier suppression : 40 dB
  - Unwanted sideband suppression : 55 dB
  - Microphone impedance : 600 Ω
- \* The output power of GMDSS version is provided for output power from the AT-130/E antenna tuner.

### Receiver

- Sensitivity
 

J3E, R3E, J2B, F1B, A1A (for 12 dB SINAD) :	0.5 μV (1.8 – 29.9999 MHz) 1.0 μV (1.6 – 1.7999 MHz) 6.3 μV (0.5 – 1.5999 MHz)
H3E (10 dB S/N)	3.2 μV (1.8 – 29.9999 MHz) 6.3 μV (1.6 – 1.7999 MHz) 32 μV (0.5 – 1.5999 MHz)
- Spurious response rejection : 70 dB (1.6 – 29.9999 MHz)
- Audio output power : 4.5 W (at 10% distortion with a 4 Ω load)
- Audio impedance : 4 to 8 Ω
- Clarity variable range : ±150 Hz

All stated specifications are subject to change without notice or obligation.

## Options

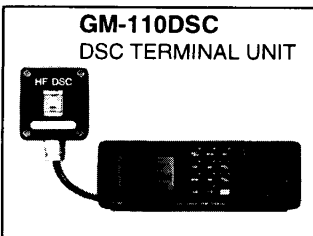

6 channel emergency scanning receiver that contains the remote control capability of the IC-M710 GMDSS for distress calls, selective calls, etc. Distress switch-box attached.



Matches the transceiver to a long wire antenna with a minimum of insertion loss.

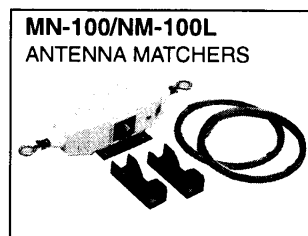

Match the transceiver to a long wire antenna without applying DC power. Antenna wire attached to the matchers:  
MN-100 : 8 m × 2  
MN-100L : 15 m × 1

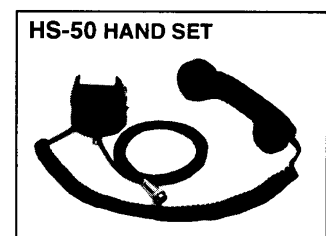

Provides better audio reception during offshore conditions and comes in handy for listening privacy on board.

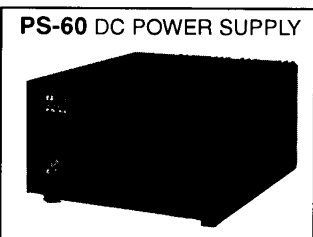

Provides 13.6 V DC (30 A) output from an AC outlet.

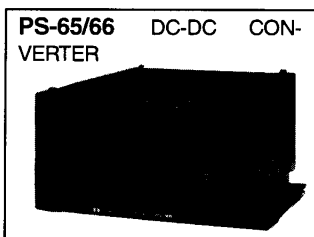

Provides 13.6 V DC (30 A) output from a 10.5-16 V (PS-65), 19-32 V (PS-66) DC power source.

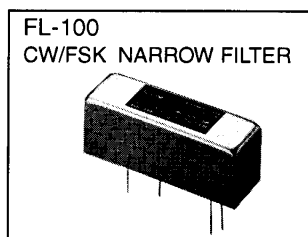

Allows better receiver selectivity for CW and FSK. (bandwidth: 500 Hz/-6 dB) GMDSS versions already have an improved narrow filter.



Provides an alarm transmission for emergency use during maritime operation. Built-in to marine and GMDSS versions.

**Count on us!**

**Icom America Inc.**

<Corporate Headquarters>  
2380 116th Avenue N.E., Bellevue, WA 98004, U.S.A.  
Phone : (425) 454-8155 Fax : (425) 454-1509  
URL : <http://www.icomamerica.com>

<Customer Service>  
Phone : (425) 454-7619

**Icom Canada**

Glenwood Centre #150-6165 Highway 17,  
Delta, B.C., V4K 5B8, Canada  
Phone : (604) 952-4266 Fax : (604) 952-0090  
URL : <http://www.icomcanada.com>

**Icom (Australia) Pty. Ltd.**

A.C.N. 006 092 575  
290-294 Albert Street, Brunswick,  
Victoria, 3056, Australia  
Phone : 03 9387 0666 Fax : 03 9387 0022

**Icom New Zealand**

146A Harris Road, East Tamaki,  
Auckland, New Zealand  
Phone : 09 274 4062 Fax : 09 274 4708

**Icom (Europe) GmbH**

Communication Equipment  
Himmelgeister Str. 100,  
D-40225 Düsseldorf, Germany  
Phone : 0211 346047 Fax : 0211 333639  
URL : <http://www.icomeurope.com>

**Icom Spain S.L.**

Crta. de Gracia a Manresa Km. 14,750  
08190 Sant Cugat del Valles Barcelona, SPAIN  
Phone : (93) 590 26 70 Fax : (93) 589 04 46  
URL : <http://www.icomspain.com>

**Icom (UK) Ltd.**

Unit 9, Sea St., Herne Bay, Kent, CT6 8LD, U.K.  
Phone : 01227 741741 Fax : 01227 741742  
URL : <http://www.icomuk.co.uk>

**Icom France S.a**

Zac de la Plaine, Rue Brindejont des Moulinais  
BP 5804, 31505 Toulouse Cedex, France  
Phone : 561 36 03 03 Fax : 561 36 03 00  
URL : <http://www.icom-france.com>

**Asia Icom Inc.**

6F No. 68, Sec. 1 Cheng-Teh Road,  
Taipei, Taiwan, R.O.C.  
Phone : (02) 2559 1899 Fax : (02) 2559 1874